

TOILET ACCESSORIES LEGEND & MOUNTING HEIGHTS

REACH RANGE (RR) TO OPERATION
RR ≤ 48" AFF WHERE < 20" COUNTER DEPTH
RR ≤ 44" AFF WHERE 20"-25" COUNTER DEPTH
RR 24"-44" AFF WHERE NO COUNTERTOP

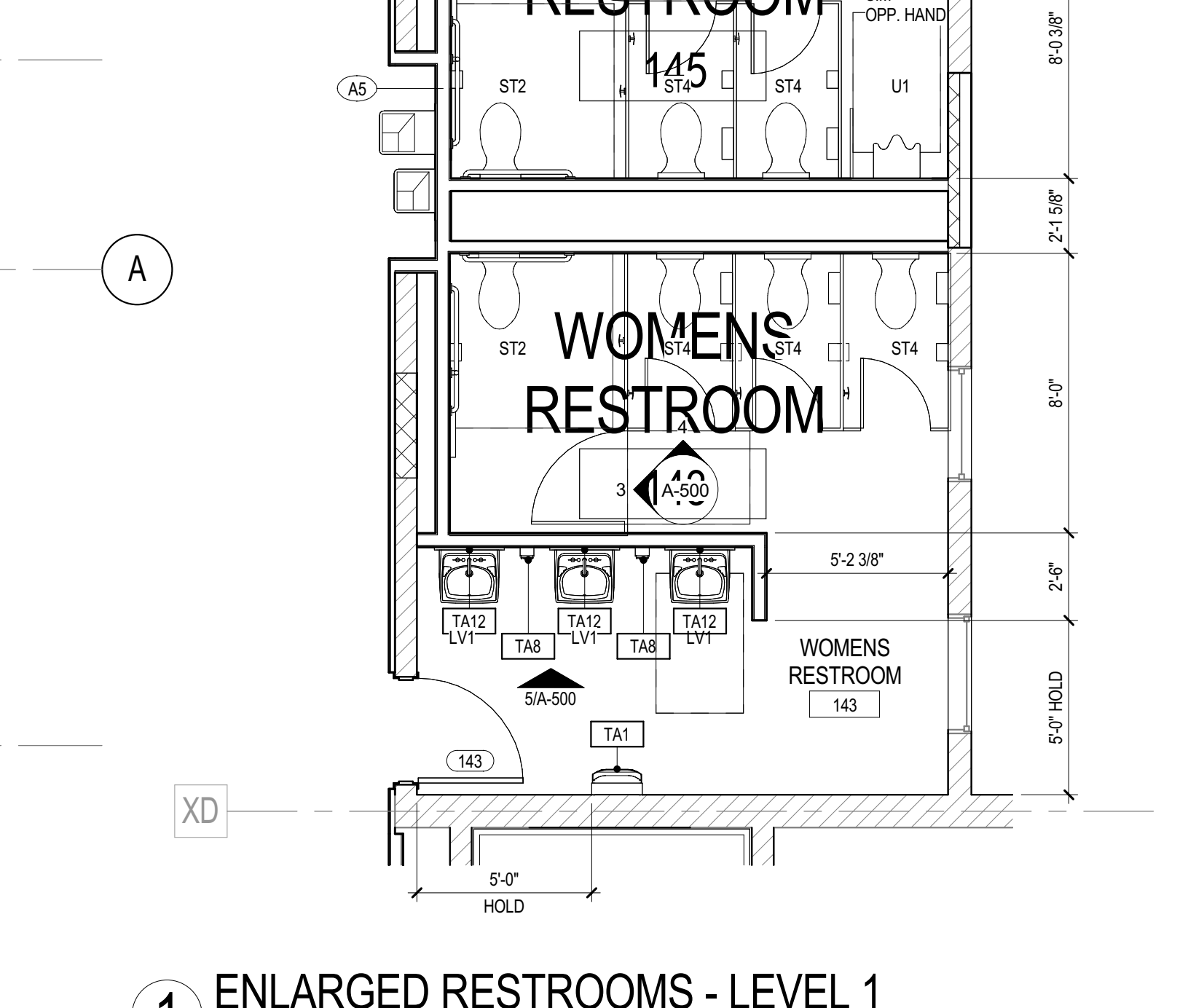
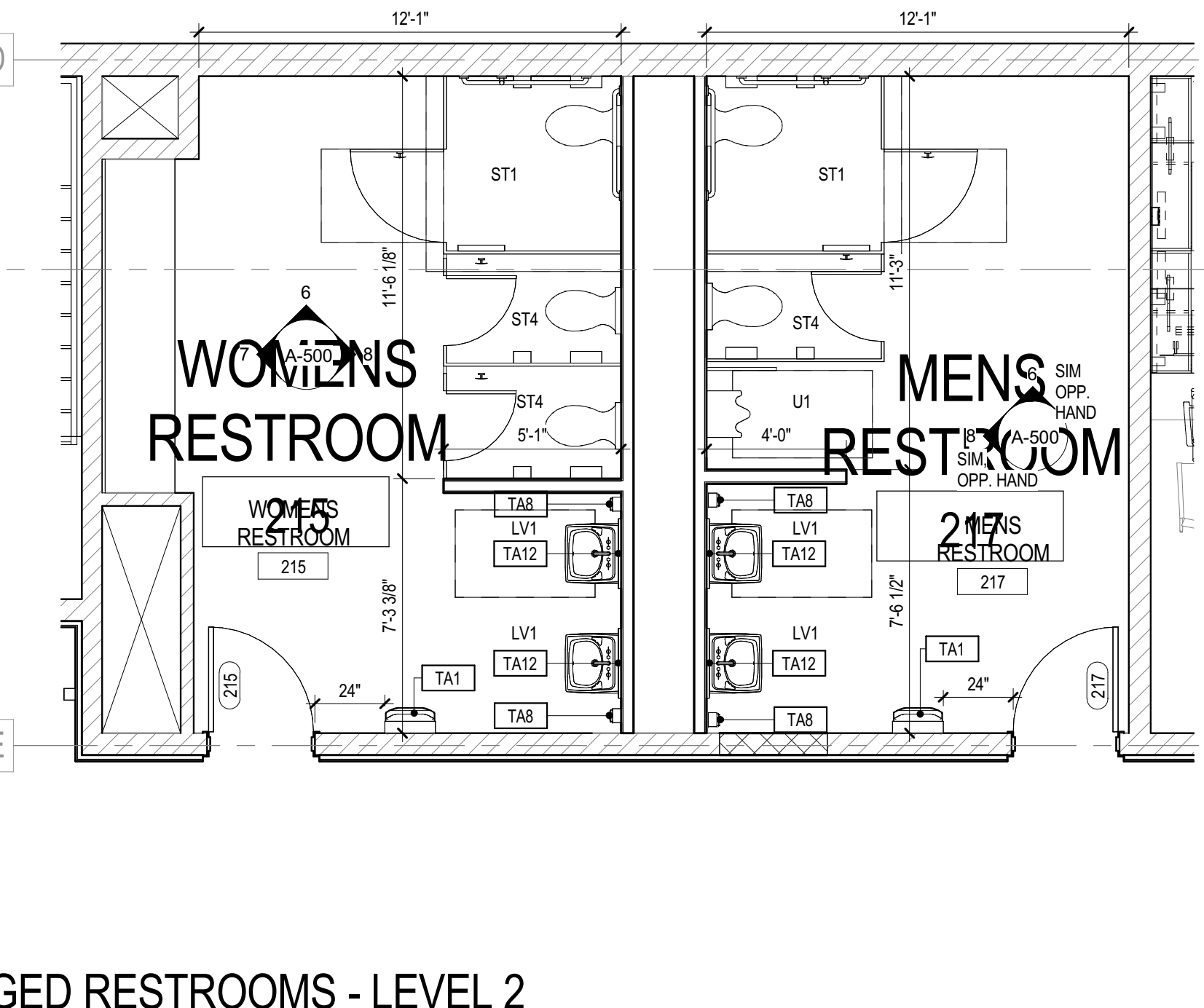
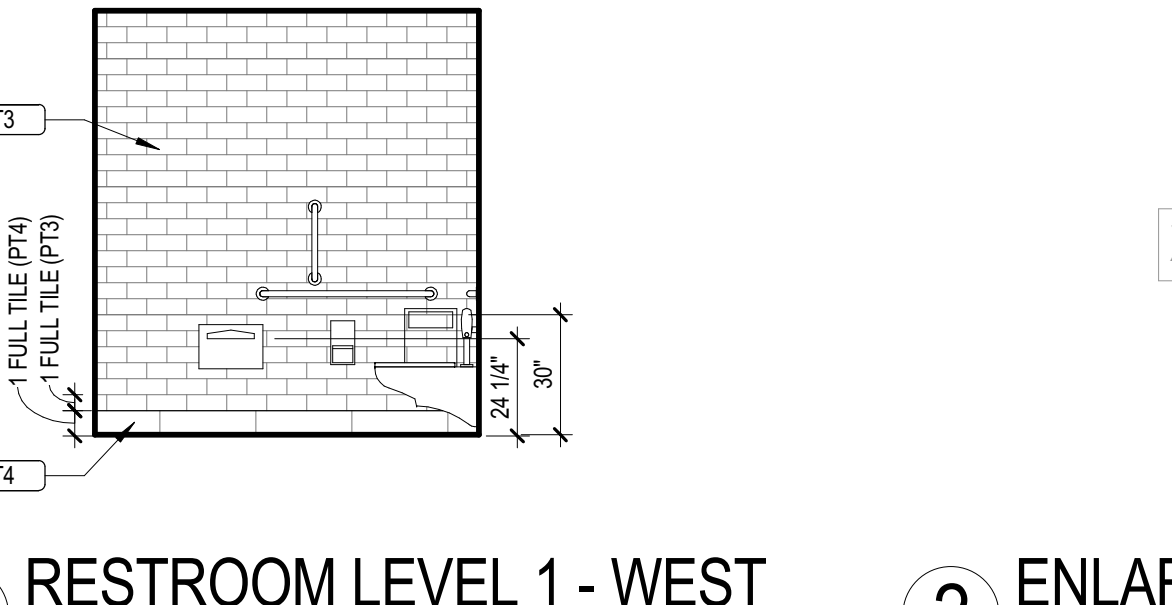
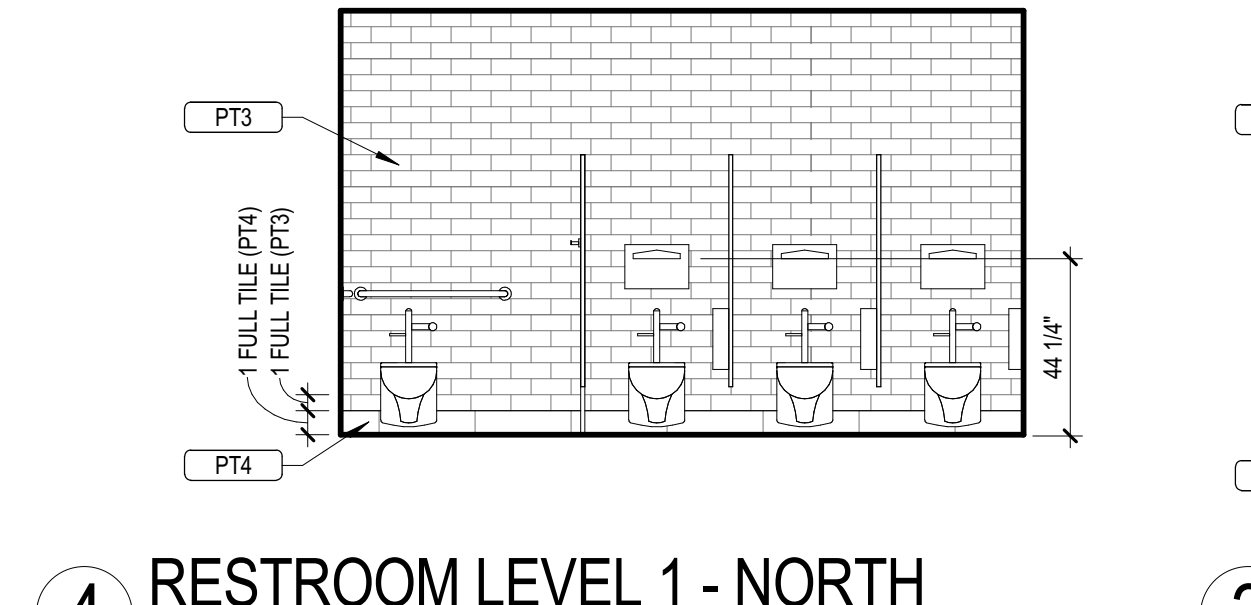
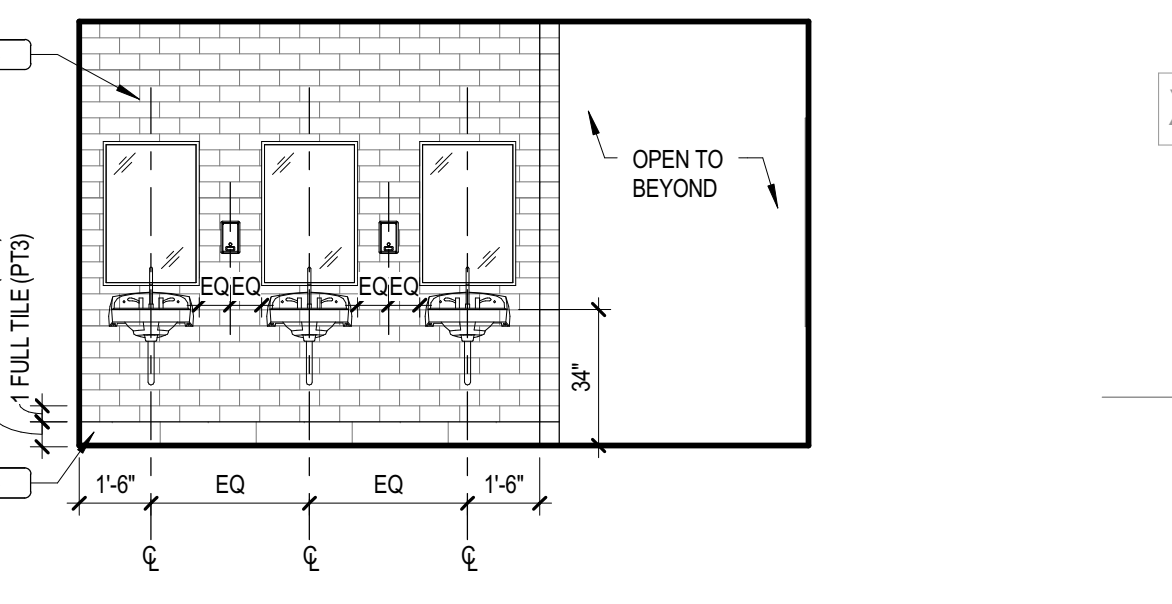
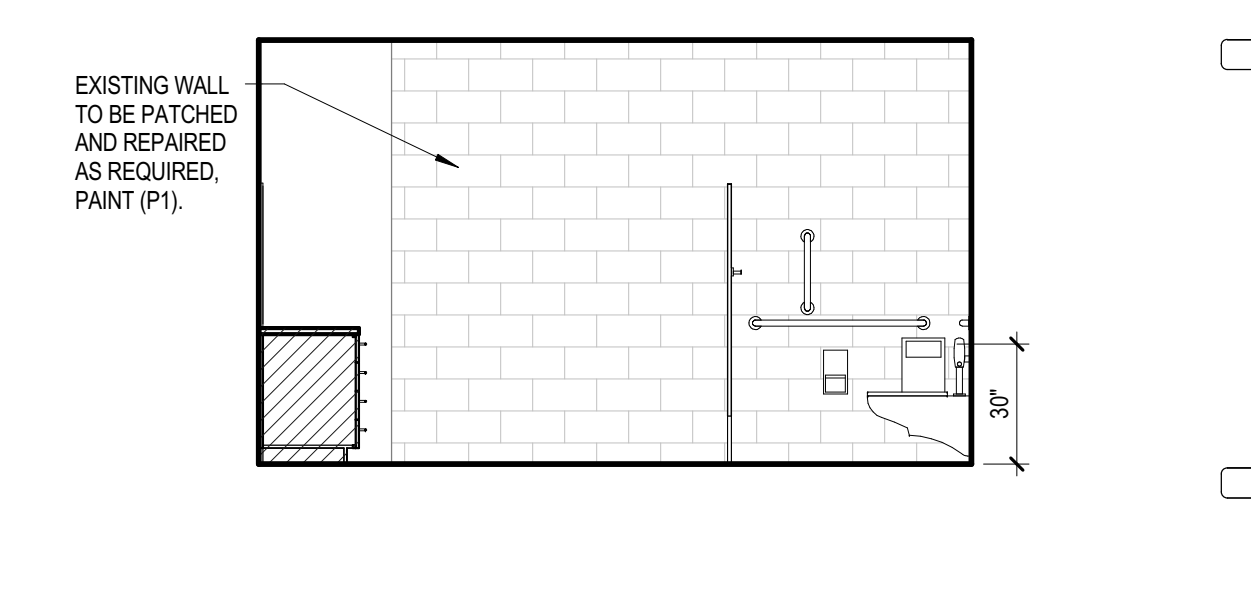
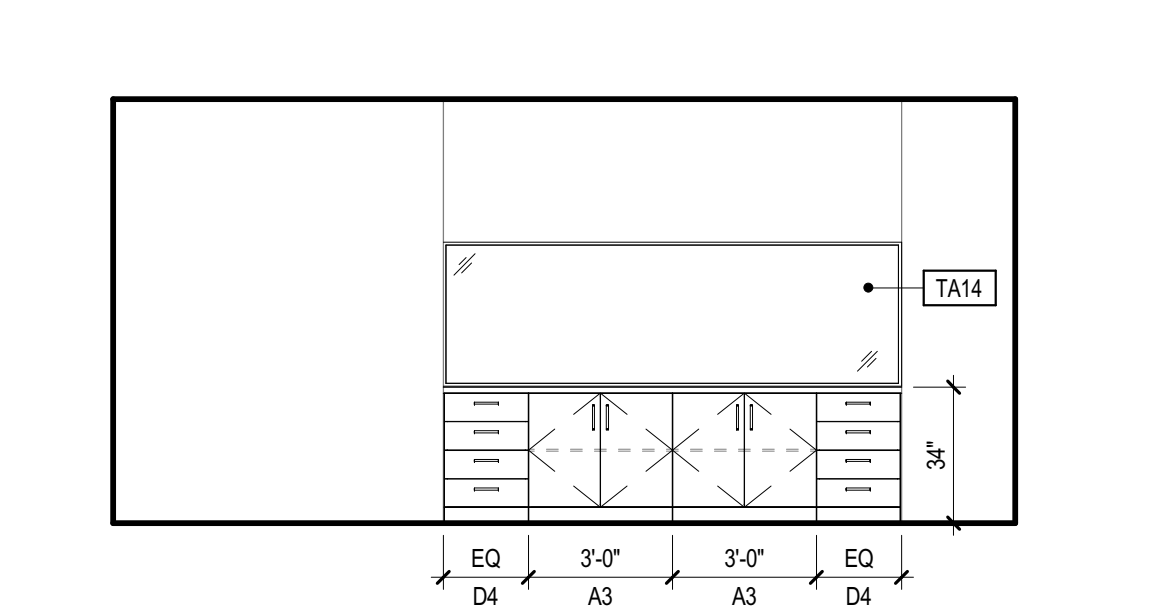
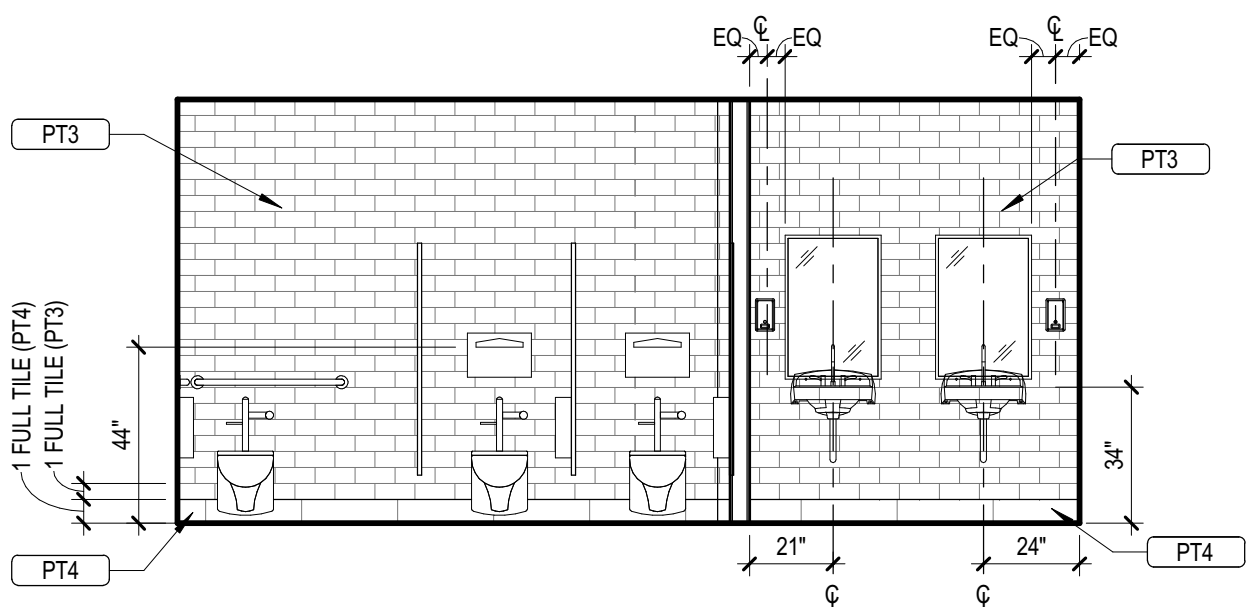
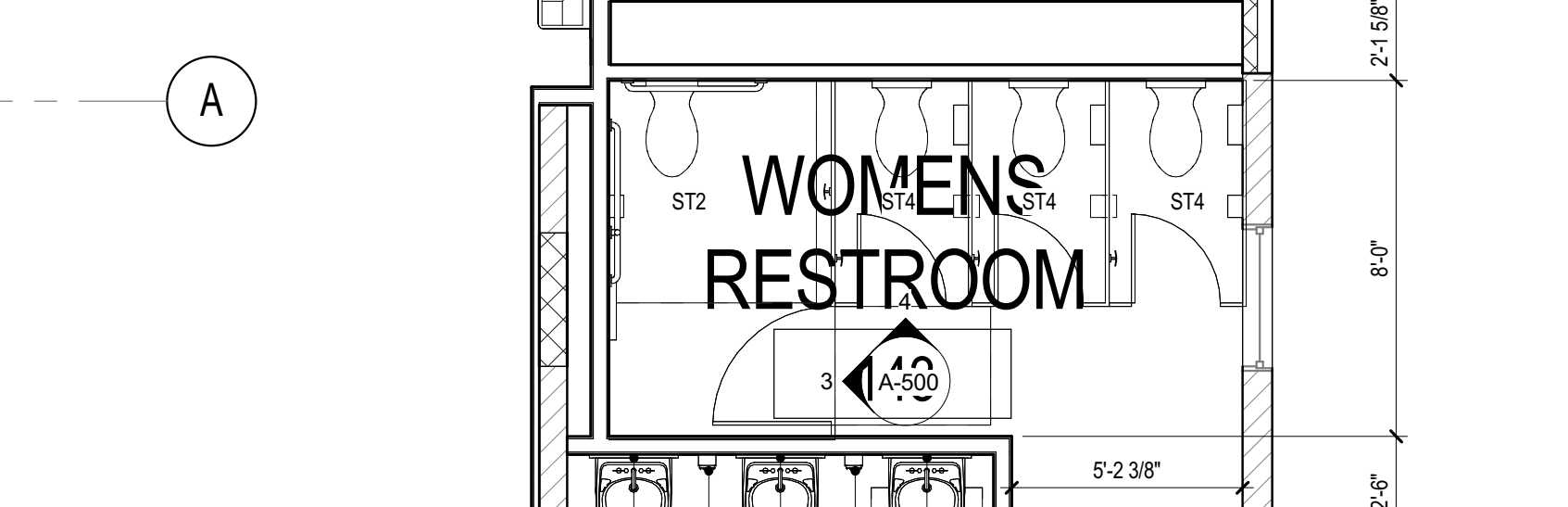
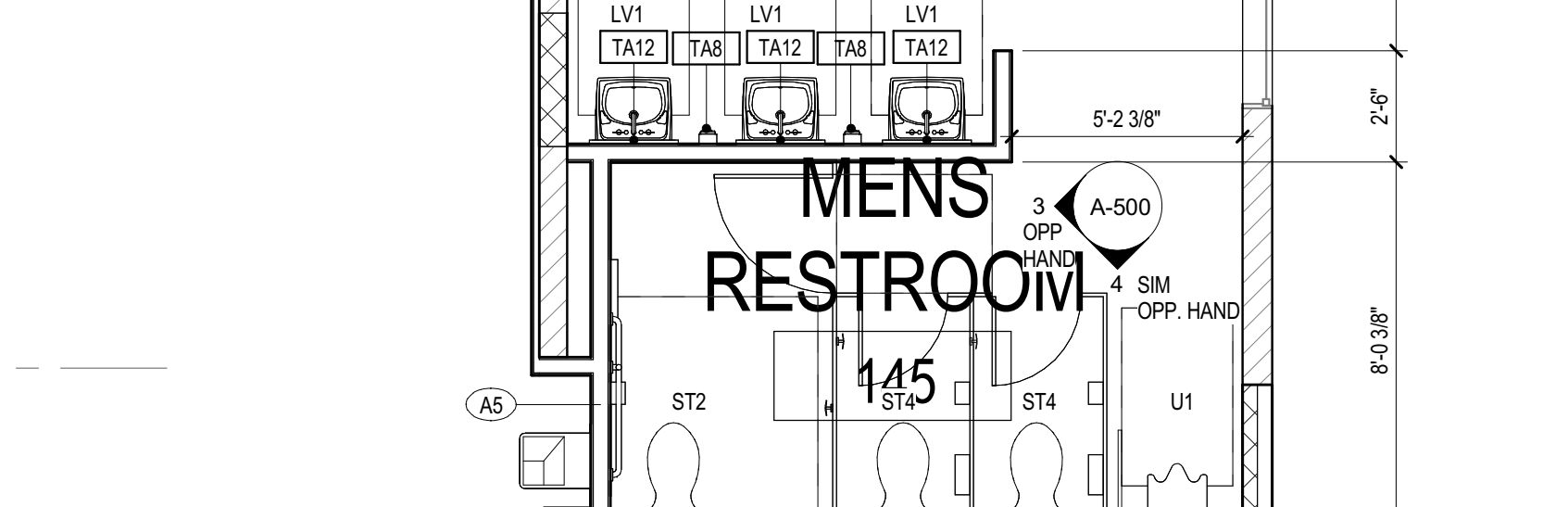
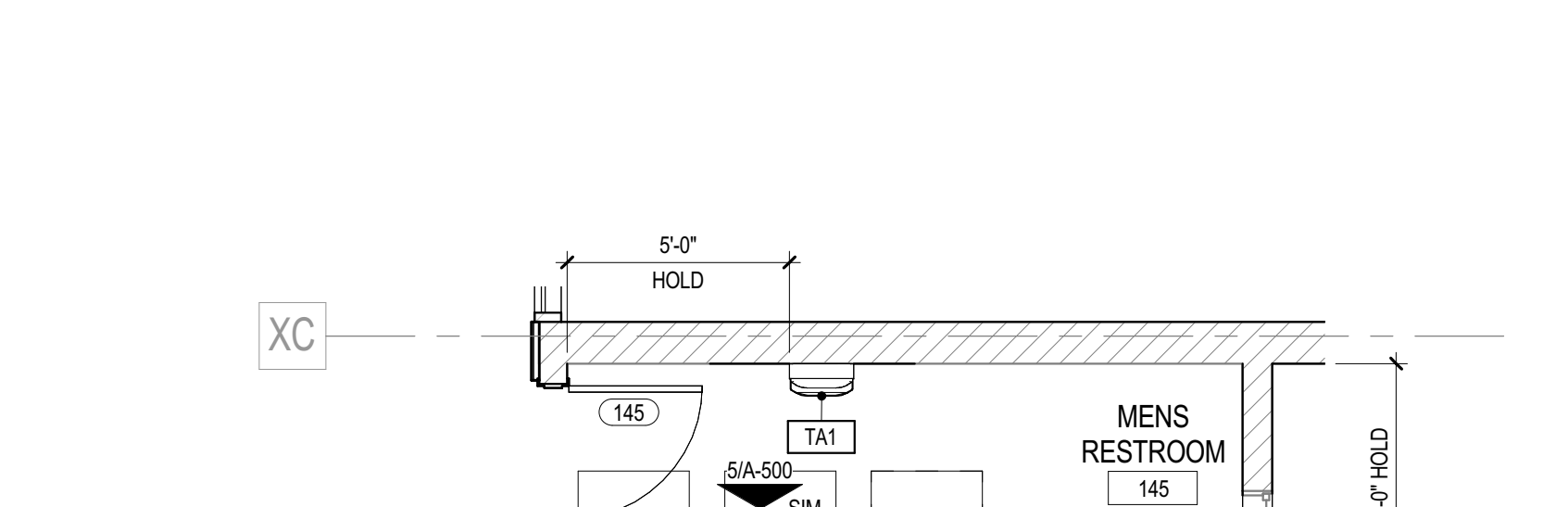
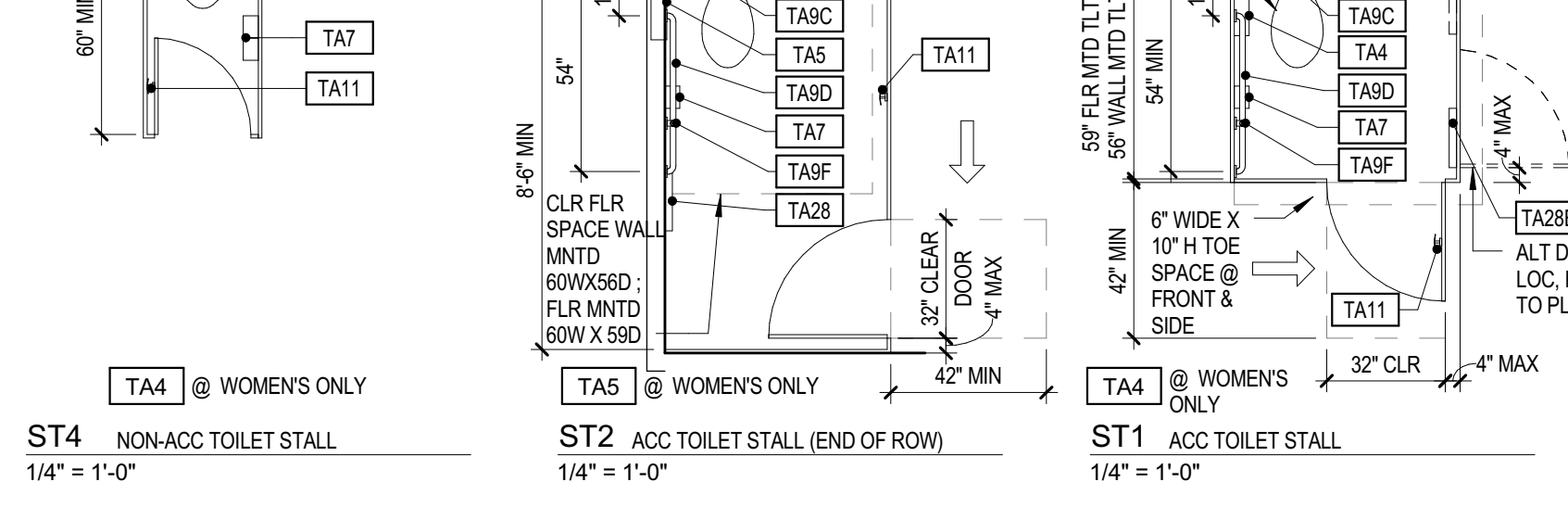
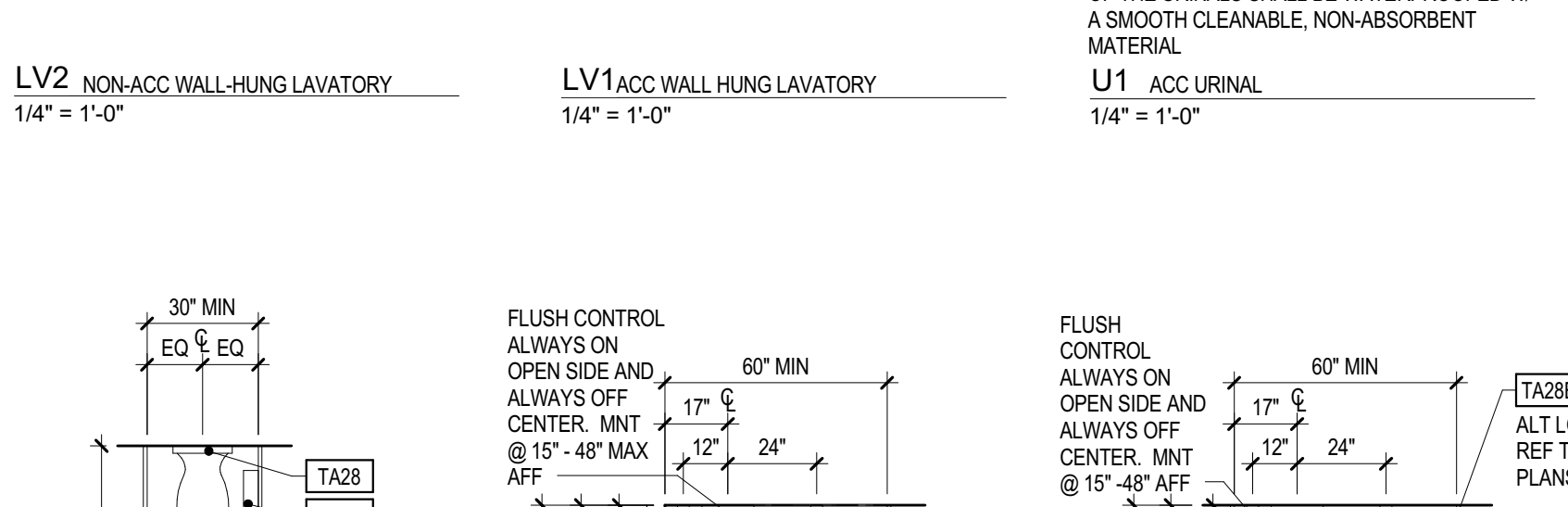
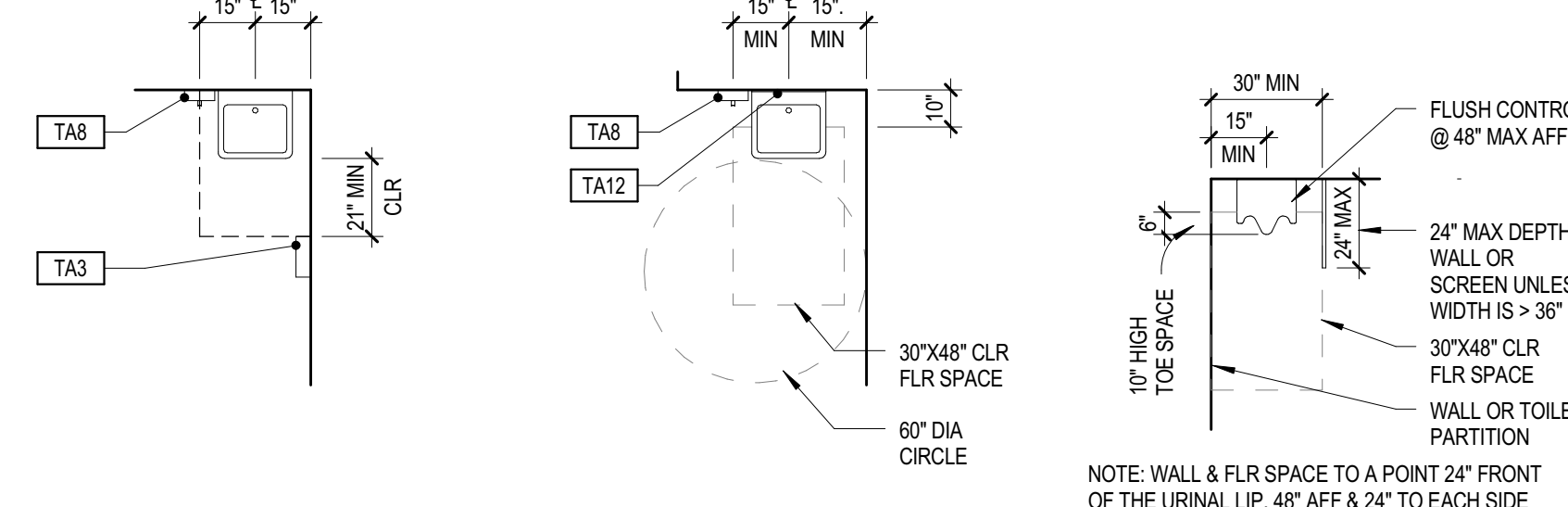
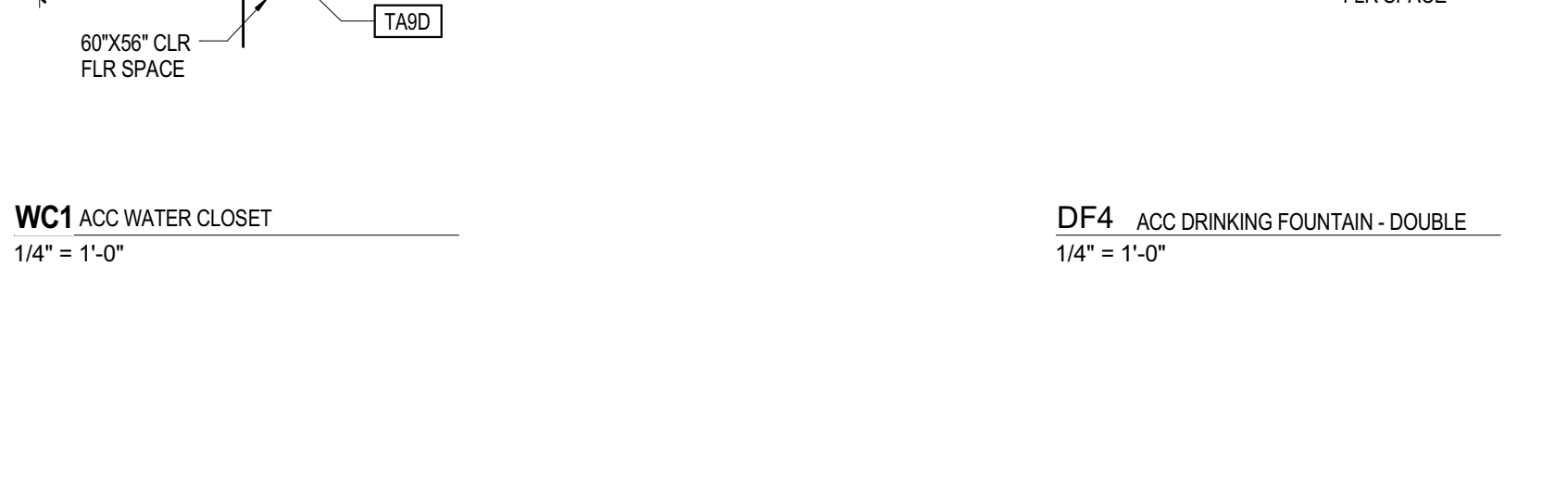
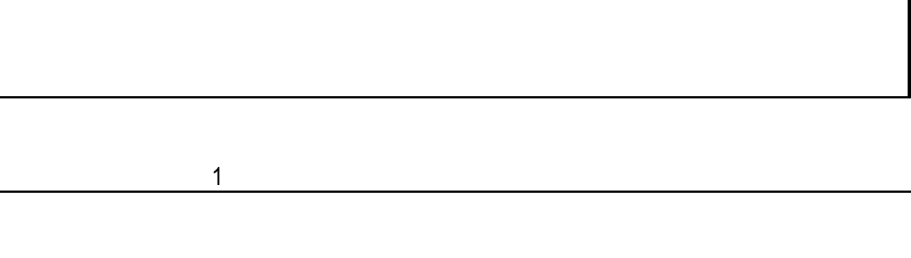
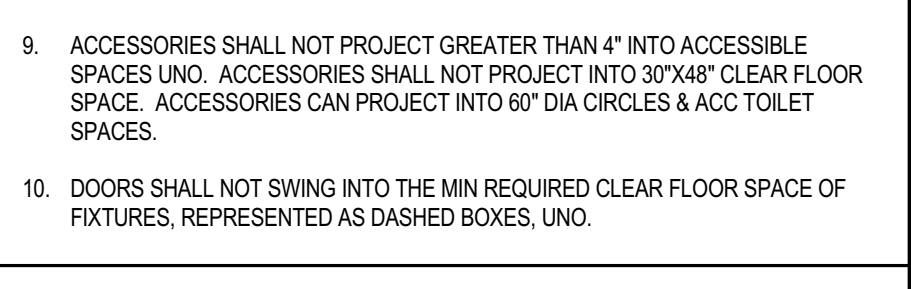
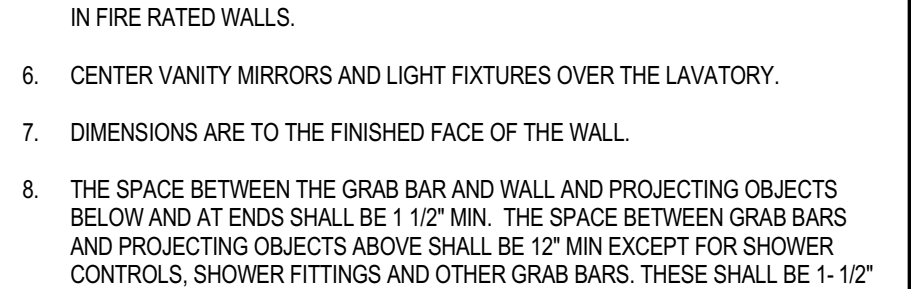
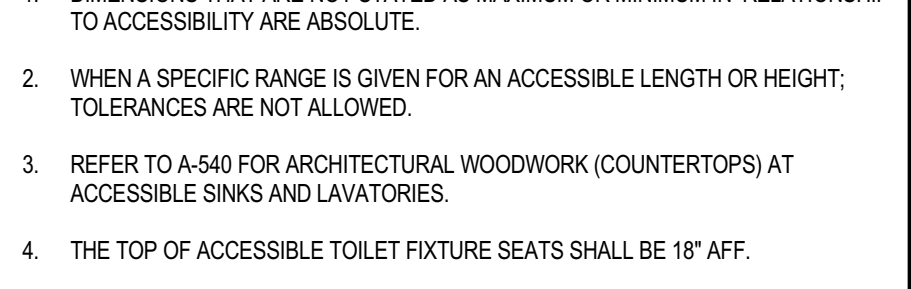
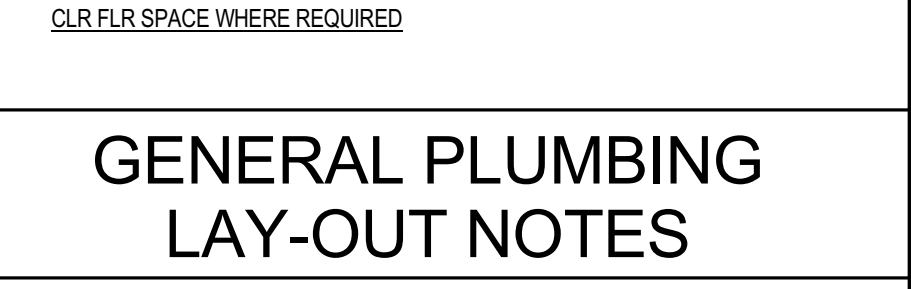
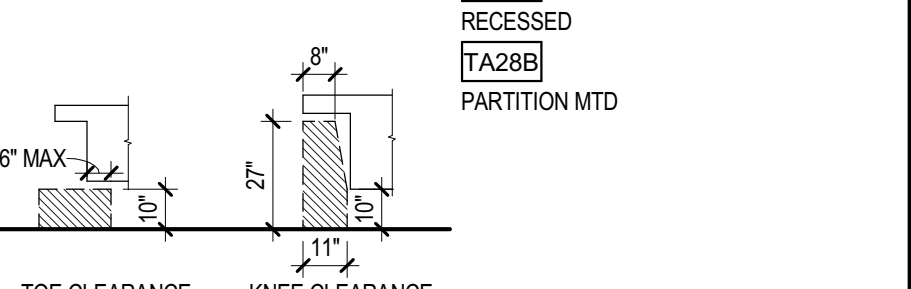
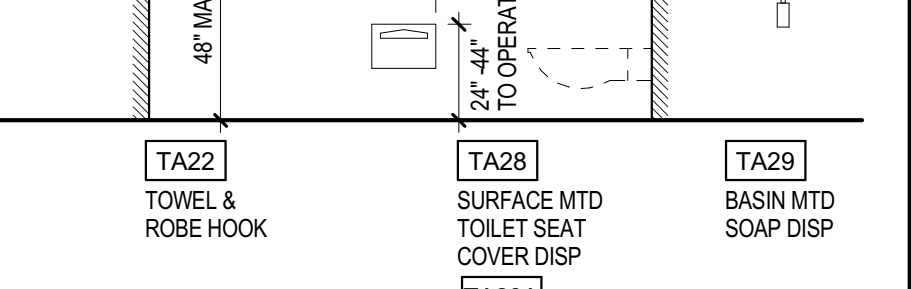
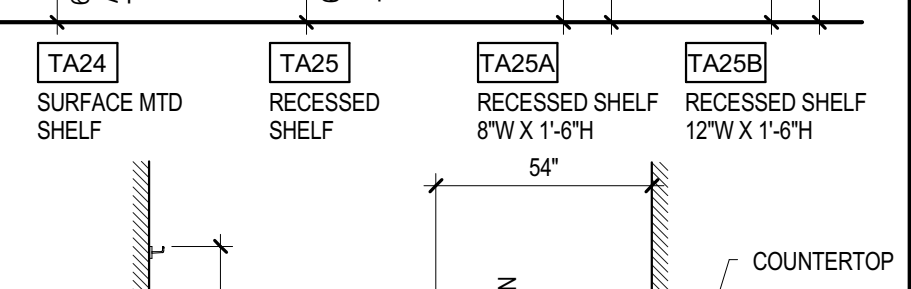
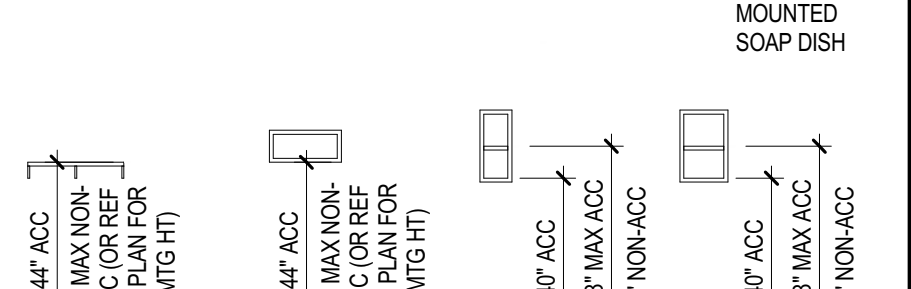
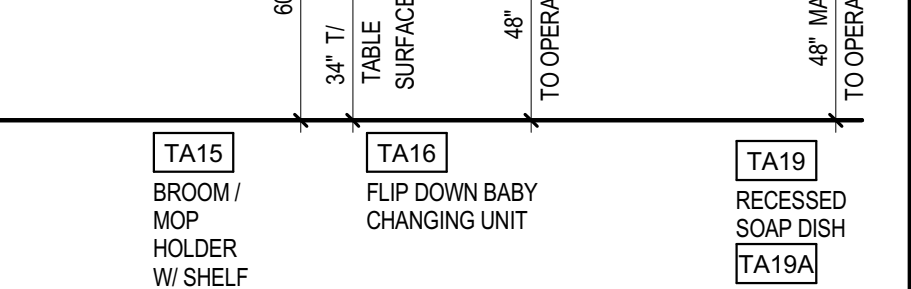
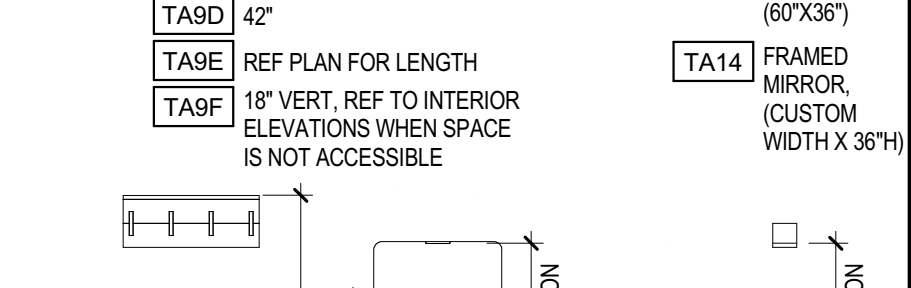
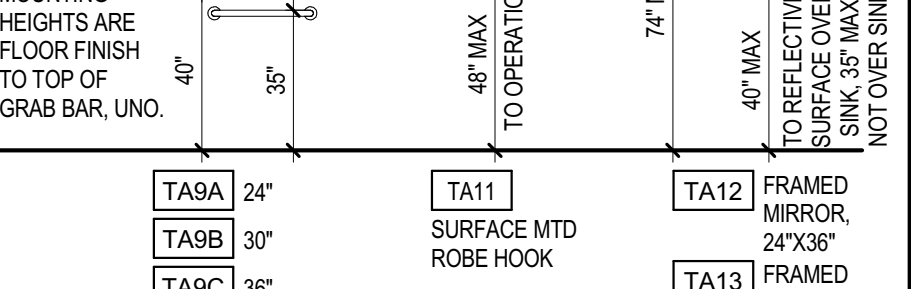
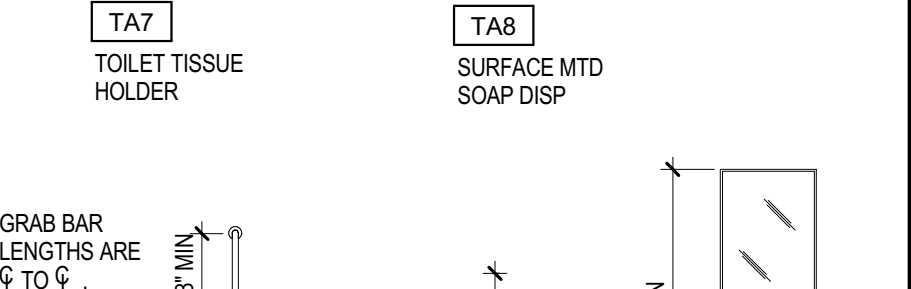
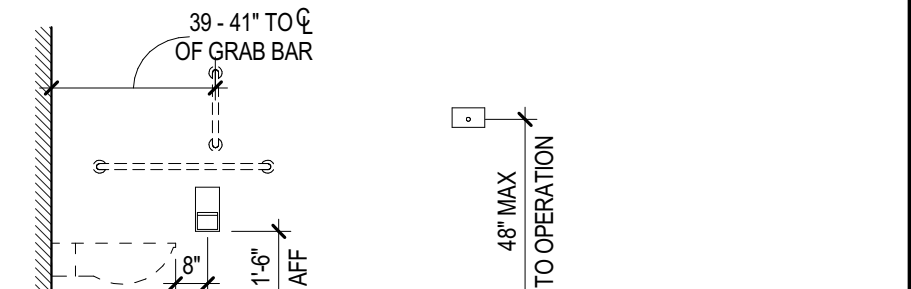
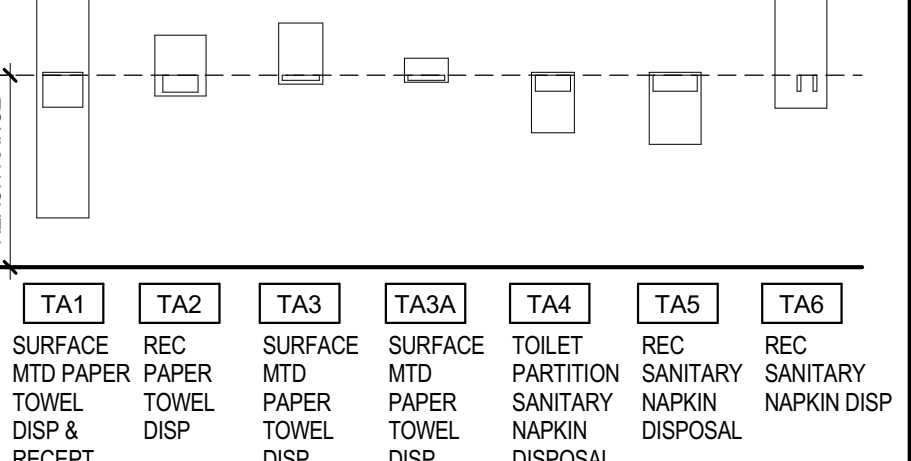

GENERAL PLUMBING LAY-OUT NOTES

- DIMENSIONS THAT ARE NOT STATED AS MAXIMUM OR MINIMUM IN RELATIONSHIP TO ACCESSIBILITY ARE ABSOLUTE.
- WHEN A SPECIFIC RANGE IS GIVEN FOR AN ACCESSIBLE LENGTH OR HEIGHT, TOLERANCES ARE NOT ALLOWED.
- REFER TO A-540 FOR ARCHITECTURAL WOODWORK (COUNTERTOPS) AT ACCESSIBLE SINKS AND LAVATORIES.
- THE TOP OF ACCESSIBLE TOILET FIXTURE SEATS SHALL BE 18" AFF.
- REFER TO A-01 FOR CODE COMPLIANCE DETAIL AT RECESS TOILET ACCESSORIES IN FIRE RATED WALLS.
- CENTER VANITY MIRRORS AND LIGHT FIXTURES OVER THE LAVATORY.
- DIMENSIONS ARE TO THE FINISHED FACE OF THE WALL.
- THE SPACE BETWEEN THE GRAB BAR AND WALL AND PROJECTING OBJECTS BELOW AND AT ENDS SHALL BE 1 1/2" MIN. THE SPACE BETWEEN GRAB BARS AND PROJECTING OBJECTS ABOVE SHALL BE 12" MIN EXCEPT FOR SHOWER CONTROLS, SHOWER FITTINGS AND OTHER GRAB BARS. THESE SHALL BE 1 - 1 1/2" MIN. GRAB BARS SHALL BE ONE AND ONE-HALF INCHES IN DIAMETER.
- ACCESSORIES SHALL NOT PROJECT GREATER THAN 4" INTO ACCESSIBLE SPACES UNO. ACCESSORIES SHALL NOT PROJECT INTO 30" X 48" CLEAR FLOOR SPACE. ACCESSORIES CAN PROJECT INTO 60" DIA CIRCLES & ACC TOILET SPACES.
- DOORS SHALL NOT SWING INTO THE MIN REQUIRED CLEAR FLOOR SPACE OF FIXTURES, REPRESENTED AS DASHED BOXES, UNO.

NO	ISSUE	DATE
Sheet Information		
Date	AUGUST 25, 2016	
Job Number	146054.000	
Drawn	NE	
Checked	TW	
Approved	RGV	
Title		
PLUMBING LAYOUTS		

Sheet
A-500